

SONAC® 120

DATA SHEET Liquid Level

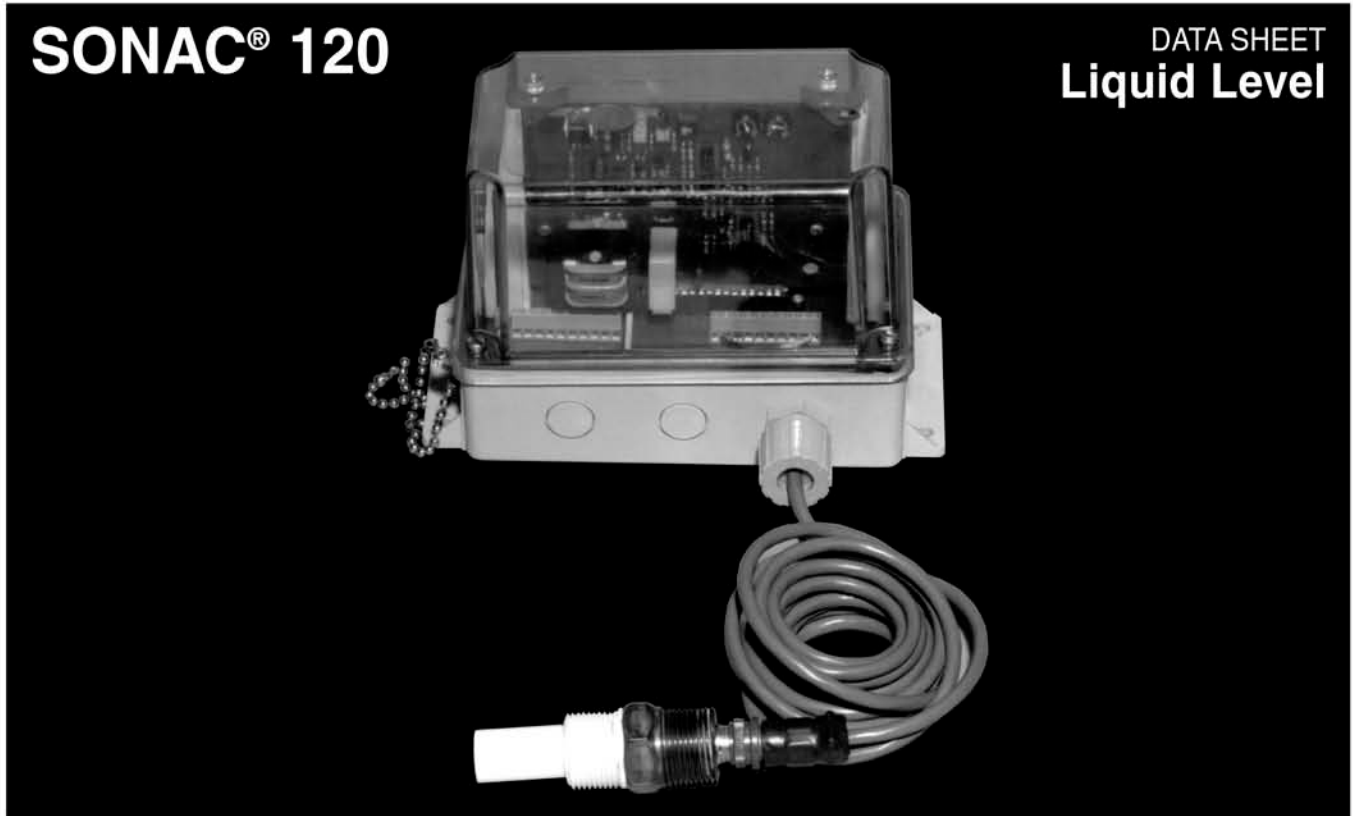

■ FUNCTION

Single Point Switch for on-off control of liquid level

■ TYPICAL USES

High Level Alarm or Control
Pump Control or Inlet Starvation Alarm
Flow/No Flow Indication
Low Level Alarm or Control

■ PRIMARY AREAS OF APPLICATION

The Delavan **Sonac® 120** is a reliable level control that will sense almost any liquid. Its fail-safe features insure positive level control in critical processes. The non-intrusive feature of its sensor permit its installation in extremely small vessels and pipes.

Non-dedicated vessels - liquids

The device senses virtually any liquid and does not need adjustment when the density or dielectric constants are changed.

High temperature, high pressure service

The welded, all stainless steel sensor body is designed for service at temperatures to 400°F (+205°C) and pressures to 2,000 psig.

Fluids with foam blankets

The control ignores foam to sense the true liquid level.

Precision level control requirements

Repeatability to 0.050 inches standard.

■ FEATURES

- **Autotest self-checking**
The unique self-checking feedback loop constantly "proves" that the control is working properly and offers superior reliability in critical applications.
- **Really fail-safe**
System is field adjusted to high or low level fail-safe conditions (relay normal with power loss). The **Sonac® 120** is designed so that any electrical or mechanical failure of Sensor or Component will cause the relay to transfer to the alarm mode.
- **Stable, dependable performance**
This sensing technique provides a wet/dry ratio of 100:1 to provide dependable performance year in and out, without periodic adjustment.
- **Corrosion resistant sensors**
Standard sensor is 316 stainless steel. Optional models are available in Hastelloy C.
- **No false trips due to surge or splashing liquids**
Non-integrating time delays reset until sensor remains wet or dry for the total time period desired.
- **Corrosion resistant, watertight remote enclosure**
Glass-reinforced polyester enclosure features captive hardware and stainless steel trim, to endure the most corrosive environments.
- **Versatile power supply**
The standard units are designed to accept 115 Volts AC, 230 Volts AC or low voltage DC input power.



PRINCIPLE OF OPERATION

The sensor is a magnetostrictive device consisting of a diaphragm, nickel tube, magnet, drive coil and pickup coil.

When power is supplied to the drive coil, it causes the diaphragm to vibrate at a frequency determined by the mechanical resonant system of the sensor. Electrical energy is transferred to the pickup coil when the diaphragm is free to move in gas. When the diaphragm motion is loaded by a liquid, less energy is transferred to the pickup coil.

The pickup coil of the sensor is connected to the input of an amplifier and the output of the amplifier to the drive coil to form a feedback loop circuit. Any energy appearing in the output of the probe will be fed to the amplifier, amplified and returned to the input of the probe. This causes vibrations at 40kHz to occur in the diaphragm and furnish a signal back to the amplifier for re-amplification. When the gain of the amplifier is adjusted so as to exceed the losses within the probe, continuous oscillations are produced.

If the diaphragm of the sensor is exposed to a liquid material which offers greater mechanical resistance to the motion of the diaphragm, the transfer of energy to the pickup coil decreases. This results in a decrease in the signal feedback into the amplifier and a corresponding decrease in the signal available from the output of the amplifier. The decreased signal triggers a voltage sensitive network that controls the output relay.

A unique AUTOTEST self-checking circuit constantly verifies the integrity of the sensor circuits. If the frequency of the sensor circuits change beyond a certain limit, the RED LED will go out. If the change of state occurs due to a level change, the relay will follow and change its state. However, if the change of state is due to a sensor failure or some other component failure, the relay will immediately de-energize to the alarm condition. This foolproof feature protects the system for loss of power, major component failure or damaged sensor conditions.

SPECIFICATIONS

| | | |
|------------------------------|--|------------------|
| Input Voltage | NOMINAL | ABSOLUTE LIMITS |
| | 115 Volts AC | 90-135 Volts AC |
| | 230 Volts AC | 180-270 Volts AC |
| | 24 Volts DC | ±4 Volts |
| Power | 3 volt-amperes | |
| Frequency, AC Power | 50-60 Hz | |
| Time Delay | Adjustable non-integrating on wet, dry | |
| Delay Time Range | 50 milliseconds min. to 10 seconds nom. Long Delay @ 30 seconds max. | |
| Fail-safe | Switch Selectable - High Level or Low Level High Level Fail-Safe Position: Relay is de-energized when product is present (wet) Low Level Fail-Safe Position: Relay is de-energized when product is not present (dry) | |
| Indicators | Two, light emitting diodes (LED) YELLOW - illuminated when relay is energized. RED - illuminated when product is present at sensor. | |
| Operating Temperature | -40°F to +160°F (-40°C to +71°C) | |
| Output | Relay, DPDT Form C | |
| Ratings | 5 amp @ 120 Volts AC Resistive 3 amp @ 240 Volts AC Resistive 3 amp @ 24 Volts DC Resistive | |
| Maximum Cable Length | PVC - 100 feet (30.5M) Teflon - 60 feet (18.3M) | |
| Shipping Weight | Control Unit - 5 pounds (2.25 kilograms) Sensor - 1.5 pounds (0.68 kilograms) Cable - 0.5 pounds (0.45 kilogram) | |

Sensor Typical Cross Section

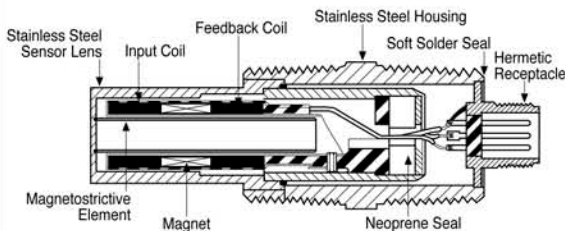

Patented Closed Loop Self Testing Circuit

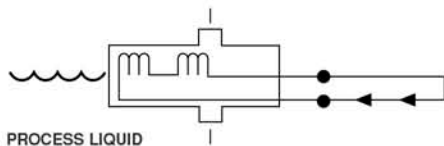

Installation Drawing

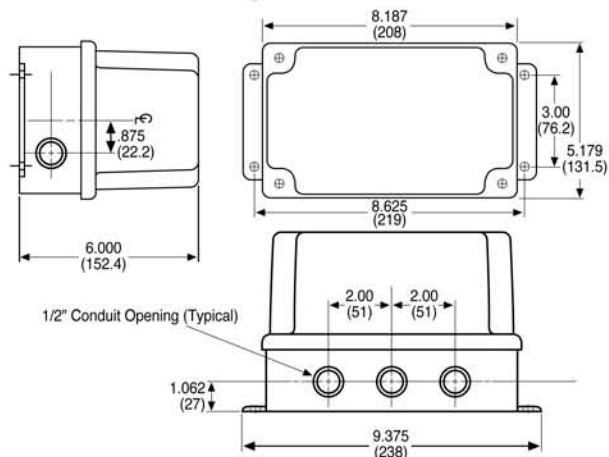

NOTE: DIMENSIONS IN PARENTHESES DENOTE MILLIMETERS

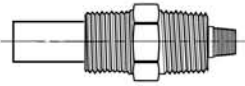
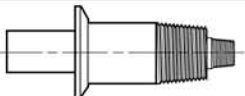

SPECIFICATIONS — Sensor

| Sensor | Model No. | Type | Description |
|---|-----------|--|--|
|  | 21 | General Purpose | 316 Stainless Steel Temp. Range: -65°F to +220°F (-54°C to +104°C) Pressure: 2,000 psi |
| | 22 | High Temperature | 316 Stainless Steel Temp. Range: -65°F to +400°F (-54°C to +204°C) Pressure: 2,000 psi |
| | 24 | General Purpose Sintered Teflon Coated for non-stick | 316 Stainless Steel Temp. Range: -65°F to +220°F (-54°C to +104°C) Pressure: 2,000 psi |
|  | 25 | High Temperature — Sintered Teflon Coated for non-stick | 316 Stainless Steel Temp. Range: -65°F to +400°F (-54°C to +204°C) Pressure: 2,000 psi |
| | 28 | Sanitary - Ladish Fitting (USDA Approval for AAA Sanitary Service) | 316 Stainless Steel Temp. Range: -65°F to +220°F (-54°C to +104°C) Pressure: 2,000 psi |

| Type Analysis | C | Mn | P | S | Si | Cr | Ni | Other Elements |
|---------------------|-------|-------|--------|--------|-------|--------------|--------------|----------------|
| 316 Stainless Steel | 0.08% | 2.00% | 0.045% | 0.030% | 1.00% | 16.00/18.00% | 10.00/14.00% | — |

Single Sensor, Sanitary Ladish Fitting (USDA Approved for AAA Sanitary Service)

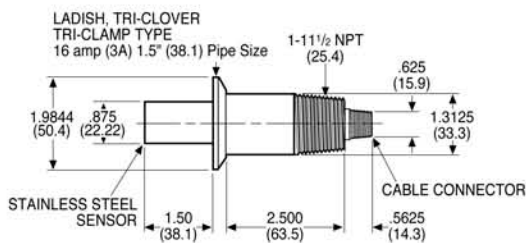

Single Sensor, Standard Hex Fitting

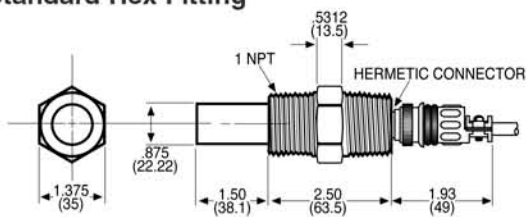

NOTE: DIMENSIONS IN PARENTHESES DENOTE MILLIMETERS

Installation Suggestions

Vertical Installation

Installation for Small Vessels or Pipes

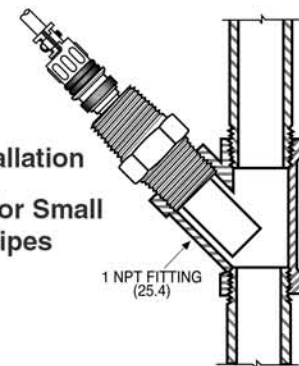

Sensor with Conduit Attachment

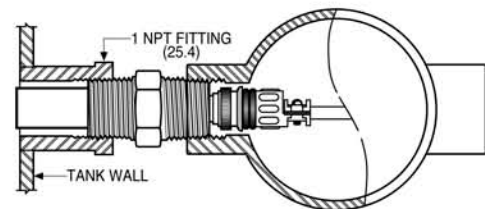

NOTE: DIMENSIONS IN PARENTHESES DENOTE MILLIMETERS

■ SENSOR CABLE ASSEMBLIES AND ACCESSORIES

| Cable Part No. | Type | Description |
|----------------|------------------|--|
| 23273 | High Temperature | 10 ft. Teflon Cable Assembly - Temp Range: Recommended if temp. will exceed 200°F (93°C) Used with sensors #22, #25 |
| 23274 | High Temperature | 30 ft. Teflon Cable Assembly - Temp Range: Recommended if temp. will exceed 200°F (93°C) Used with sensors #22, #25 |
| 23275 | High Temperature | 60 ft. Teflon Cable Assembly - Temp Range: Recommended if temp. will exceed 200°F (93°C) Used with sensors #22, #25 |
| 23276 | General Purpose | 10 ft. PVC Cable Assembly - Used with sensors #21, #24, #28 |
| 23277 | General Purpose | 50 ft. PVC Cable Assembly - Used with sensors #21, #24, #28 |
| 23278 | General Purpose | 100 ft. PVC Cable Assembly - Used with sensors #21, #24, #28 |

■ CUSTOMER CONNECTIONS

SONAC® 120

| GND. | NEUT | 115 VAC | 230 VAC | NC | C | NO | NC | C | NO |
|------|------|---------|---------|----------------|---|----|----|---|----|
| | | | | RELAY CONTACTS | | | | | |
| 1 | 2 | 3 | 4 | 5 | 6 | 7 | 8 | 9 | 10 |

| SENSOR BLACK | SENSOR SHIELD | | | | + | - | | | SENSOR WHITE |
|--------------|---------------|----|----|----|----------------|---|----|----|--------------|
| 11 | 12 | 13 | 14 | 15 | LOW VOLT INPUT | | 18 | 19 | 20 |

■ ORDERING INFORMATION

SONAC®

120- _____ - _____ - _____

Interconnect Cable

- P50 = PVC 50 ft. cable (160°F max)
- P100 = PVC 100 ft. cable (160°F max)
- T10 = Teflon 10 ft. High Temp. Cable (400°F max)
- T30 = Teflon 30 ft. High Temp Cable (400°F max)

Sensor Type

- 21 = Standard, 316 Stainless Steel, 1" NPT (220°F max)
- 22 = High Temp, 316 Stainless Steel, 1" NPT (400°F max)
- 24 = 316 Stainless Steel, Coated with Teflon, 1" NPT (220°F max)
- 25 = High Temp, Coated with Teflon, 1" NPT (400°F max)
- 28 = Sanitary, 316 Stainless Steel with 316 Stainless Steel, 1-1/2" Tri-Clover (220°F max)
- 21H = Hastelloy C, 1" NPT (220°F max)

Enclosure Type

- S = Standard, NEMA 4X Enclosure
- C = Clear NEMA 4X Enclosure
- O = OEM, Electronic Assembly with Mounting Hardware (No Enclosure)

Model Sonac® 120 Remote Mount
Magnetostrictive Liquid Level Sensor

DELAVAN Process Instrumentation
an **L&J TECHNOLOGIES** Company

5911 Butterfield Road
Hillside, IL 60162
Ph: (708) 236-6000
Fax: (708) 236-6006
Email: sales@ljtechnologies.com

